

Features

Standard module for SwitcherGear

Interface for three-phase SEMIKRON™ SEMIKUBE converter with single 34-way ribbon cable connection

6x PWM switch signals

HALT signal

3x analogue phase currents

Analogue DC link voltage

Heat-sink temperature

24 V supply output

Applications

3-phase voltage source inverter

motor drives

grid interface

renewable energy

power quality

DC-DC converter

Buck, boost, buck-boost

Battery

Photo-voltaic

Energy storage

General Description

The CON003 module is a SwitcherGear hardware interface module for SEMIKRON SEMIKUBE 3-phase integrated converters. The module includes control power for the converter and all control and measurement signals in a single 34-way ribbon cable.

Ordering Information

Order Code	Description
CON003	SwitcherGear Module, 3-phase integrated converter interface, SEMIKRON SEMIKUBE
CBL005/2m0	SwitcherGear Accessory, 34-way ribbon cable, 2 metres long

™ The trademarks SEMIKRON, SEMIKUBE and SEMIKUBE SlimLine are the property of SEMIKRON Elektronik GmbH.

Module Quick Start

1. Set the configurable features.

Determine the feature settings that are required for the system under control. If necessary, change the default solder jumper settings. Refer to the Configuration section.

2. Review the allocation of the MCU interface signals.

Confirm that the MCU interface signals connect to appropriate pins on the host MCU. Refer to your SwitcherGear configuration document and Table 3.

3. Insert into the base slot.

Refer to your SwitcherGear configuration document for the location of modules.

4. Connect the external wiring to the system connector.

Refer to Table 1 for the pin-out of the system connector.

Standard Interfaces

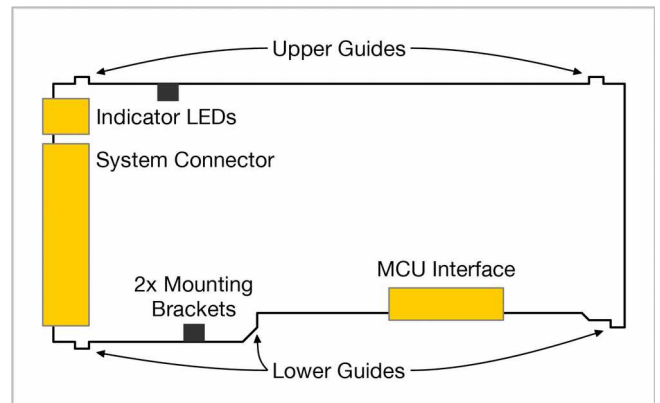

Figure 1: Parts of a SwitcherGear module.

System Connector

The system connector is the connector interface to the external power system.

The CON003 module has one 34-way shrouded pin header for the connection of a ribbon cable that connects to the SEMIKUBE converter. The header is a standard 2×17 pin header with 2.54 mm pitch. Table 1 shows the pin-out of the 34-way header.

See Applications Information for information about the mating ribbon cable.

Refer to SEMIKRON documentation for detailed information about SEMIKUBE converters.

Indicator LEDs

Eight miniature indicator LEDs on the front panel show the status of the module. Refer to Table 2 for details.

Table 1: System connector, 34-way shrouded pin header. Signal names are derived from SEMIKUBE user manual.

Pin	Signal	Description	Pin	Signal	Description
1	PWR_VP	+24 VDC supply output.	2	PWR_GND	Ground for supply output.
3	PWR_VP	+24 VDC supply output.	4	PWR_GND	Ground for supply output.
5	PWR_VP	+24 VDC supply output.	6	PWR_GND	Ground for supply output.
7	-	-	8	CMN_GND	Ground for CMN_nHALT signal.
9	CMN_nHALT	Halt signal input. Active low.	10	-	-
11	TEMP_ANLG	Heatsink temperature signal input.	12	TEMP_AGND	Ground for TEMP_ANLG signal.
13	UDC_ANLG	DC link voltage signal input.	14	UDC_AGND	Ground for UDC_ANLG signal.
15	HB1_TOP	Half-bridge 1 top switch signal output.	16	HB1_BOT	Half-bridge 1 bottom switch signal output.
17	-	-	18	HB1_GND	Ground for HB1_TOP and HB1_BOT signals.
19	HB1_ANLG	Half-bridge 1 phase current signal input.	20	HB1_AGND	Ground for HB1_ANLG signal.
21	HB2_TOP	Half-bridge 2 top switch signal output.	22	HB2_BOT	Half-bridge 2 bottom switch signal output.
23	-	-	24	HB2_GND	Ground for HB2_TOP and HB2_BOT signals.
25	HB2_ANLG	Half-bridge 2 phase current signal input.	26	HB2_AGND	Ground for HB2_ANLG signal.
27	HB3_TOP	Half-bridge 3 top switch signal output.	28	HB3_BOT	Half-bridge 3 bottom switch signal output.
29	-	-	30	HB3_GND	Ground for HB3_TOP and HB3_BOT signals.
31	HB3_ANLG	Half-bridge 3 phase current signal input.	32	HB3_AGND	Ground for HB3_ANLG signal.
33	-	-	34	-	-

Table 2: Indicator LEDs









Appearance	Left Column		Right Column	
	Colour	Description	Colour	Description
 	Green	+24 V supply	Red	Halt active
 	Green	Half-bridge 1 top or bottom switch active	-	-
 	Green	Half-bridge 2 top or bottom switch active	-	-
 	Green	Half-bridge 3 top or bottom switch active	-	-

Table 3: MCU interface

Pin	Signal	Description
D0	HB1BOT	Half-bridge 1 bottom switch signal input. Active-high.
D1	HB1TOP	Half-bridge 1 top switch signal input. Active-high.
D2	HB2BOT	Half-bridge 2 bottom switch signal input. Active-high.
D3	HB2TOP	Half-bridge 2 top switch signal input. Active-high.
D4	HB3BOT	Half-bridge 3 bottom switch signal input. Active-high.
D5	HB3TOP	Half-bridge 3 top switch signal input. Active-high.
D6	HALTn	Halt signal output. Active-low.
D7	CSn	Device select input for SPI bus.
D8	SCLK	SPI bus clock input.
D9	-	-
D10	SOMI	SPI bus data output.
D11	-	-
A0	IHB1	Half-bridge 1 phase current signal output.
A1	IHB2	Half-bridge 2 phase current signal output.
A2	IHB3	Half-bridge 3 phase current signal output.
A3	VDC	DC link voltage signal output.

MCU Interface

The MCU interface connects analogue and digital signals between the module and the host MCU.

Refer to Table 3 for details of the digital and analogue signals provided by the MCU interface of this module.

Refer to the SwitcherGear Configuration Document for your specific SwitcherGear unit for information on the routing of signals between the installed modules and the host MCU.

Configuration

Current Measurement Range

The measurement range of the phase current signals can be scaled to match the maximum working current of the application. The measurement range is configured using solder jumpers on the back side of the module.

The phase current signal output from SEMIKUBE converters is fixed to a measurement range that covers the maximum rating of the converter. Refer to SEMIKRON documentation for details. However, depending on the application, the working current range may be lower than this maximum range. The CON003 module can be configured for a smaller measurement, which can optimise the utilisation of the ADC of the host MCU.

By default, the measurement range of the CON003 module covers the maximum range that is available from the SEMIKUBE converter. For applications where the working current is less than the maximum available range, the measurement range can be configured to a smaller, suitable range.

Table 4 and Table 5 show the jumper settings for the various current measurement ranges and converter types. The default setting of the jumpers is shown in grey highlight. “S” and “O” indicate shorted and open settings for the jumpers, respectively.

Table 4: Configuration of current range for standard SEMIKUBE converters – see datasheet for driver board current scaling.

Measurement Range		Current Range Jumpers			
Driver Board Current Scaling		A	B	C	D
24 mV/A	12 mV/A				
113	225	S	S	O	S
142	284	O	S	O	S
169	339	S	O	O	S
199	398	O	O	O	S
225	450	S	S	S	O
254	509	O	S	S	O
282	564	S	O	S	O
311	623	O	O	S	O
338	675	S	S	O	O
367	734	O	S	O	O
394	789	S	O	O	O
424	848	O	O	O	O

Table 5: Configuration of current range for SEMIKUBE SlimLine converters.

Measurement Range		Current Range Jumpers			
SL20	SL40	A	B	C	D
21.87 mV/A	10.94 mV/A				
123	247	S	S	O	S
156	311	O	S	O	S
186	372	S	O	O	S
218	436	O	O	O	S
247	492	S	S	S	O
279	558	O	S	S	O
309	619	S	O	S	O
342	683	O	O	S	O
370	741	S	S	O	O
403	805	O	S	O	O
433	866	S	O	O	O
465	930	O	O	O	O

Driver Output Voltage

The voltage level of the switch signal line drivers can be configured to one of two different voltages, as shown in Table 6. The default setting of the jumper is shown in grey highlight.

The switch signal inputs of SEMIKUBE converters have an input range equal to the supply voltage. Therefore, the DRV jumper must be in the default, open state when using SEMIKUBE converters.

Table 6: Configuration of line driver output voltage.

Driver Voltage		DRV Jumper
OFF State	ON State	
0 V	+24 V	Open
0 V	+15 V	Short

Solder Jumpers



Modules are supplied with all solder jumpers in the open state. These default feature settings are highlighted in grey in the configuration tables.

If a different configuration is required for your application, you must change the solder jumper settings before using the SwitcherGear.

Solder jumpers allow configuration of SwitcherGear modules. They function like a switch to control the features of the module. Jumpers consist of two adjacent pads on the rear side of the module circuit board. The jumper can be shorted (switch closed) by making a solder bridge across the pads. The jumper can be opened (switch open) by removing the solder bridge.

The solder jumpers are intended for one-time-only configuration. No warranty is provided for damage to solder jumpers. Only skilled personnel who are trained in correct soldering technique should undertake the configuration of the solder jumpers. Incorrect technique or excessive temperature can result in the pads of the solder jumper detaching from the circuit board, rendering the jumper permanently open-circuit.

Observe the following precautions when configuring solder jumpers:

- Anti-static handling procedures.
- Turn off power before removing or inserting modules.
- Use a fine-tip soldering iron with adjustable temperature.
- Use only lead free solder and compatible tools.
- Use the minimum temperature required to perform the task.

- Do not heat the jumper for more than 5 seconds. Allow to cool before re-applying heat.
- To remove solder from a jumper, use a narrow (e.g. 1.5 mm), fluxed solder-wicking braid.

Functional Description

The CON003 module interfaces the host MCU to an external SEMIKUBE converter. The system connector of the module provides the control circuitry power and signal interfaces required to operate the converter.

Switch PWM Signals

The SEMIKUBE 3-phase converters are comprised of 3 half-bridge converters connected to a common DC link. Each phase of the converter is a half-bridge that has a top and bottom power switch (IGBT). The output voltage of each phase is controlled by using PWM signals to control the switching on and off of the power switches.

The CON003 module accepts six logic-level PWM signals from the host MCU on pins D0 thru D5 of the MCU Interface. High current line drivers translate these signals to a higher voltage and low impedance for robust transmission by ribbon cable to the SEMIKUBE converter. The line driver voltage is configurable – see section Driver Output Voltage.

A logic low level on a PWM signal turns off the corresponding IGBT, while a logic high level turns on the IGBT.

The generation of PWM signals must meet the following rules:

- prevent simultaneous turn on of the top and bottom switches of a half-bridge;
- enforce, after the turn off of one switch, a dead-time before the turn on of the opposing switch of a half-bridge; and
- remove narrow pulses.

These rules can be met by appropriate configuration of the PWM peripherals in the host MCU. The SEMIKUBE converters include protection logic that corrects the above conditions. However, it is good practice to generate “clean” PWM signals, rather than generating “dirty” signals that must be cleaned. The CON003 module does not check for or modify the PWM signals to meet these rules.

HALT Signal

The CON003 module has a halt input that receives the HALT signal from the SEMIKUBE converter. The module converts the high voltage HALT signal to a logic level signal that is compatible with the MCU. The logic sense of the signal is retained, i.e. a low voltage input from the converter gives a logic low output to the MCU.

The converter HALT signal is an open-collector signal that is pulled to ground when a fault condition is detected in the converter. The signal should be used by the MCU to immediately turn off all PWM signals and perform a graceful shutdown of the converter process.

Phase Currents

The CON003 module processes the phase current signals from the SEMIKRON converter. The processed signals are available as voltage signals on the MCU interface. The relationship between the signal voltage and phase current is shown in Figure 2.

The measurement range is configurable – see Current Measurement Range.

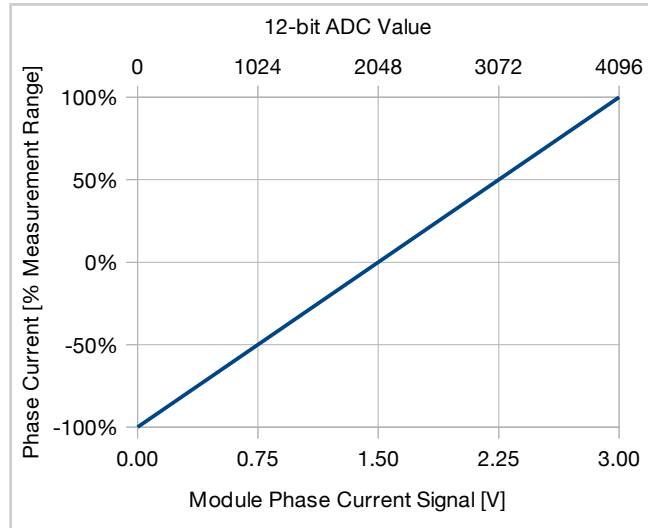

Figure 2: Phase current versus the signal on the A0-A2 MCU interface pins. The upper axis shows the correspondence of the signal voltage to ADC conversion result, assuming an ADC with 12-bit resolution and input range 0 to 3 V.

DC Link Voltage

The CON003 module processes the DC link voltage signal from the SEMIKRON converter. The processed signal is available as a voltage signal on the MCU interface. The relationship between the signal voltage and DC link voltage is shown in Figure 3.

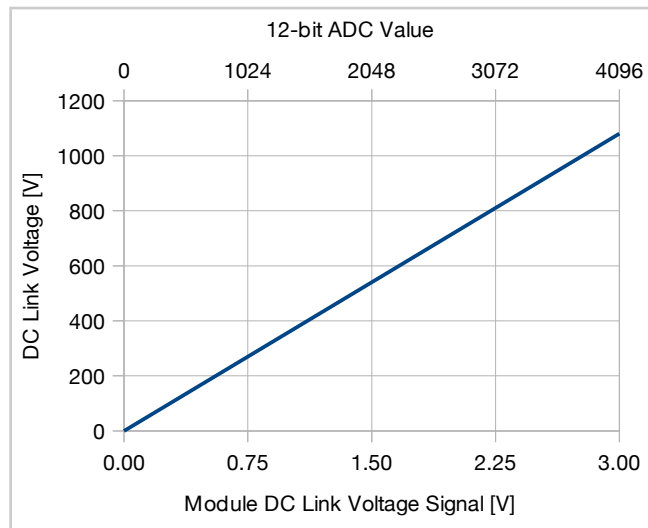

Figure 3: DC link voltage versus the signal on the A3 MCU interface pin. The upper axis shows the correspondence of the signal voltage to ADC conversion result, assuming an ADC with 12-bit resolution and input range 0 to 3 V.

Heatsink Temperature

The heatsink temperature signal is received from the SEMIKRON converter. The CON003 module performs signal processing before applying the signal to a 12-bit ADC on the module. The host MCU can read the temperature signal using the SPI bus on the MCU interface.

The value read from the ADC is in the range 0 to 4095, and can be converted to temperature using the following equations. For standard SEMIKUBE converters

$$T_{HS} = 108 \times \left[\frac{ADC}{4096} \right]$$

and for SEMIKUBE SlimLine converters

$$T_{HS} = 30 + 86.4 \times \left[\frac{ADC}{4096} \right]$$

where ADC is the value read from the ADC and T_{HS} is the heat-sink temperature in degrees C. These equations are shown graphically in Figure 4.

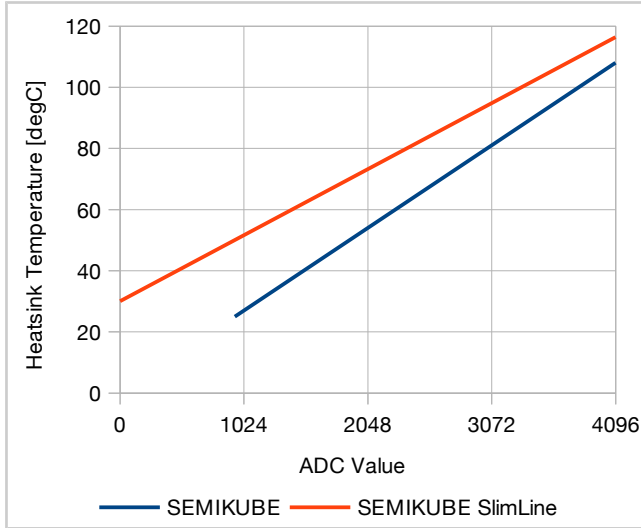

Figure 4: Heatsink temperature versus ADC value.

External Power Supply

The CON003 module has a 24 V supply output that powers the control circuitry of the connected SEMIKUBE converter. This supply output is protected against short-circuit and over-current faults by a re-settable fuse.

Applications Information

External Wiring

Ribbon cable (also known as IDC – insulation displacement cable) should be used to connect from the CON003 module system connector to the converter. Consult ordering information for suitable cables.

Alternatively, the cables are relatively simple to make yourself:

- Use standard 2x 17-way receptacle with 2.54 mm pitch and polarisation key.
- Use ribbon cable with 1.27 mm pitch.
- The coloured stripe on the ribbon cable should align with the pin 1 marking on the receptacle. This marking is typically a line or arrow.
- The system connector header on the module is keyed to ensure correct orientation of the receptacle. Ensure that the cable leads away from the connector in the correct direction.
- Use a strain relief to protect the cable/connector connection. Note that using a strain relief reverses the cable direction.

Host MCU

Texas Instruments C2000

The PWM signals for the SEMIKUBE converter should be generated using three EPWM peripherals. The HALT signal should be connected to the hardware trip mechanism. Consult the TI documentation of your chosen host MCU for further details.

SwitcherWare Library

The SwitcherWare Library contains code resources for MCU power converter applications, including

- code wrappers for MCU peripherals
 - ▷ sensor inputs using ADC
 - ▷ PWM generation using EPWM
- code wrappers for SwitcherGear modules
- event handling for real-time control
- configuration of low-level CPU registers
- coordinate transform, PI control, ramp limit, etc.

A licence to use the library is included with each SwitcherGear controller.

The SwitcherWare Library includes a C++ wrapper object for the CON003 module. Features include 3-phase PWM generation (sine and SVM), dead-time, narrow pulse removal, shutdown on converter HALT, read heatsink temperature.

The SwitcherWare Library includes other resources for the capture of the phase currents and DC link voltage, and hardware interrupts to execute a control algorithm in real-time. The Library also includes example projects of real-world converter applications.

Refer to the SwitcherWare Library documentation for details.

Warnings

- ⚠ The length of cables connected to the module system connector must not be longer than 3 m.
- ⚠ The user is responsible to ensure that the cables and connectors used for external wiring have insulation and/or separation distances that provide isolation from live parts and from earth.
- ⚠ The user is responsible to ensure that cables and connectors used for external wiring that carry live voltages have insulation and/or separation distances that provide protection against indirect contact.
- ⚠ The user is responsible to ensure that the installation provides protection against direct contact.
- ⚠ This module provides no interlock mechanism to prevent simultaneous turn-on of the top and bottom IGBTs in a half-bridge. The user is responsible to ensure that PWM gate signals are complementary and have appropriate dead-time.
- ⚠ This Module does not provide galvanic isolation between SwitcherGear and the power system under control. An appropriate isolated IGBT driver must be used to drive the IGBTs.

Absolute Maximum Ratings

Stresses above these ratings may cause permanent damage. These are stress ratings only – functional operation is not implied. Exposure to absolute maximum conditions for extended periods may affect reliability.

Parameter	Conditions	Max	Unit
HALT input voltage		30	V
Analogue inputs, voltage		±20	V
Analogue inputs, current		±20	mA

Electrical Characteristics

The following specifications apply for $V_{DC} = 24\text{ V}$, $T_A = 25\text{ °C}$.

Parameter	Conditions	Min	Typ	Max	Unit
SWITCH DRIVER OUTPUTS					
Logic 0 Output Voltage	No load			0.025	V
Logic 1 Output Voltage	DRV jumper open	$V_{DC} - 0.025$			V
	DRV jumper shorted	13.4		14.7	V
Output Resistance	$I_{OUT} = 10\text{ mA}$	100		107	Ω
Delay Time, Rising	$C_L = 1\text{ nF}$		40	60	ns
Delay Time, Falling	$C_L = 1\text{ nF}$		40	60	ns
HALT INPUT					
Low-Level Input Voltage		0		5	V
High-Level Input Voltage		15		V_{DC}	V
Open-Circuit Voltage			$V_{DC} - 0.4$		V
Input Resistance			1		k Ω
Delay time, falling	Open-collector drive to 0 V			500	ns
PHASE CURRENTS					
Accuracy	Not including SEMIKUBE			±0.5	%
Bandwidth	-3 dB		160		kHz
DC LINK VOLTAGE					
Accuracy	Not including SEMIKUBE			±0.5	%
Bandwidth	-3 dB		160		kHz
HEATSINK TEMPERATURE					
Accuracy	Not including SEMIKUBE			±0.5	°C
EXTERNAL SUPPLY					
Output voltage			V_{DC}		V
Source Resistance				0.2	Ω
Output Current	Up to 60 °C	0.95			A
Short-Circuit Current	Protection active		0.03		A

Revision History

Revision	Date	Changes From Previous Release
1	10 Aug 2018	▪ Original release.